



MOAI



www.simes.it/moai

Die-cast EN AB-47100 and extruded EN AW-6060 aluminium housing (copper free) with high corrosion resistance.

Stainless steel screws.

99.98% pure aluminium reflectors.

Clear toughened reeded glass.

Luminaire hard wired with H07RN-F cable.

Electrical wiring with fast connector IP67.

Silicone gaskets.

Double powdered paint in 3 step process:

_ surface treatment containing ceramic nano particles (Bonderite);

_ epoxy primer paint;

_ polyester powder paint with high resistance against UV rays and harsh weather conditions.

Lamp not included.

LED versions are supplied with LED circuit.

IP65

CLASS I

IK 06



Ystad bathing pier, Sweden © Fagerhult Belysning AB

COLOURS:

- Aluminium grey (code 14)
- Rusty corten (code 18)



Are supplied with H07RN-F cable and IP67 fast connector. The connector must be connected at the supply line (Ø 12÷16 mm).

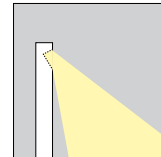

The light distribution is in accordance with light pollution regulations.

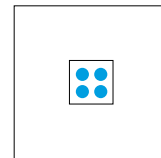

LED BLUE available on request

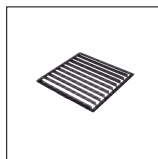

S.6159
ANTIGLARE SHIELD
for MINI MOAI

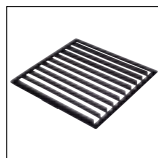

S.6169
ANTIGLARE SHIELD
for MOAI

MINI MOAI

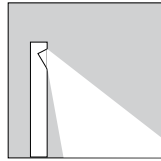
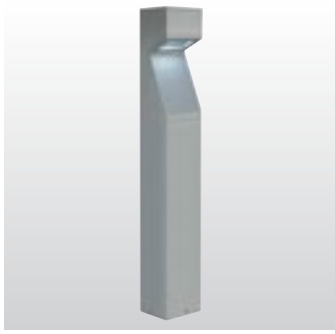

S.6157



For lamp HIT-TC CE 20W PGJ5 1650lm
 Rated luminaire luminous flux 577lm
 Rated input power 22W 240V
 With electronic ballast

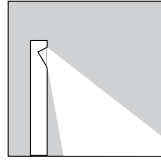
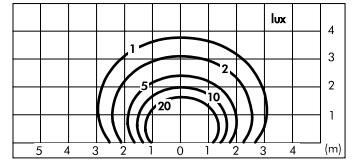
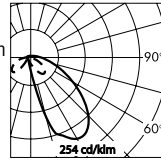

S.6150



With leds white 6000K 944lm
 Rated luminaire luminous flux 263lm
 Rated input power 11W 240V

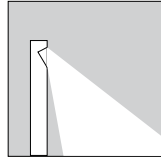
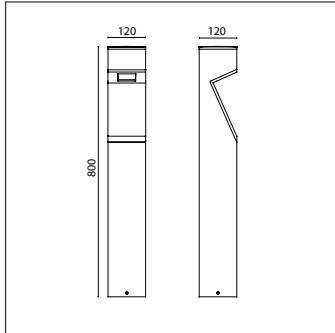
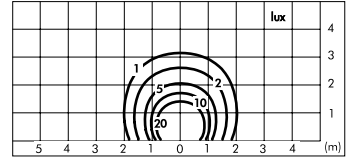
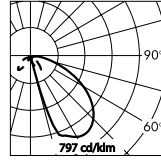

S.6150W



With leds white 3200K 777lm
 Rated luminaire luminous flux 215lm
 Rated input power 11W 240V

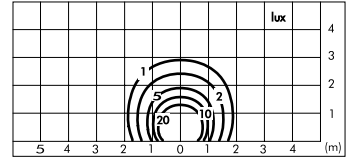
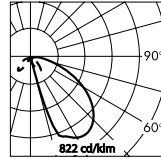

S.6099

FLANGE ACCESSORY FOR MINI MOAI

120x120mm flange to be fixed in concrete with stainless steel screws for fixing in the ground.

MOAI

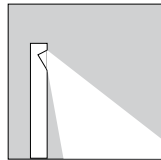

S.6167



For lamp HIT-TC CRI 35W G8,5 3300lm
 Rated luminaire luminous flux 1485lm
 Rated input power 46W 240V
 With electronic ballast

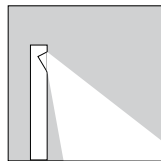
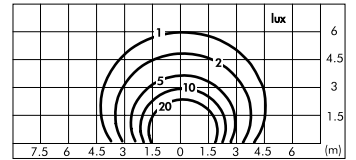
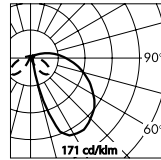

S.6160



With leds white 6000K 2360lm
 Rated luminaire luminous flux 677lm
 Rated input power 24W 240V

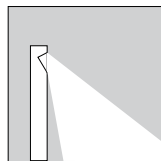
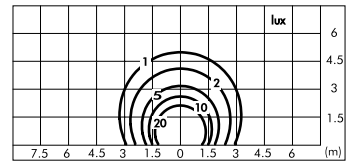
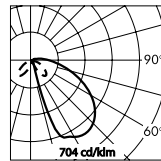

S.6160W



With leds white 3200K 1942lm
 Rated luminaire luminous flux 583lm
 Rated input power 24W 240V

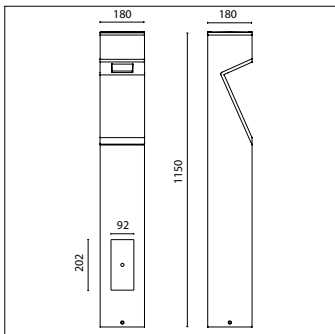
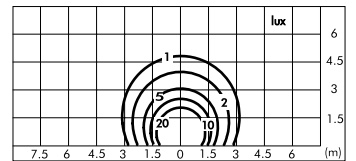
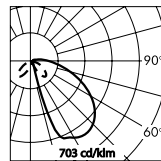

S.5310

FLANGE ACCESSORY FOR MOAI

Ø 180 mm flange to be fixed in concrete with stainless steel screws for fixing in the ground.



