

Fixture housing: galvanised steel previously stove-enamelled with UV-stabilised white polyester resin; rounded edges profile to eliminate sharp edges.

Standard supply: nylon fastening pawl and adaptor for power connection.

Emergency version: In maintained version. In the event of a black-out, one lamp connected to the back-up circuit stays on. Run time 60 minutes (see chapter). On request: A "Main Control System" to supervise the emergency versions (see chapter). On request: version with 3 hour emergency duration and RAL 7001 grey track.

6305 Elesystem T5 - onelamp							
		CEL-F		CEL-F-E		CEL-F-D	
wattage	colour	weight	code	weight	code	weight	code
FL 1x28	white	1.80	237920-00	2.30	237920-09	1.80	237920-12
FL 1x54	white	1.80	237923-00	2.30	237923-09	1.80	237923-12
FL 1x35	white	2.00	237921-00	2.65	237921-09	2.00	237921-12
FL 1x49	white	2.00	237922-00	2.65	237922-09	2.00	237922-12
FL 1x80	white	2.00	237924-00	2.65	237924-09	2.00	237924-12

6315 Elesystem T5 - twolamps							
		CEL-F		CEL-F-E		CEL-F-D	
wattage	colour	weight	code	weight	code	weight	code
FL 2x28	white	2.00	237940-00	2.50	237940-09	2.00	237940-12
FL 2x54	white	2.00	237943-00	2.50	237943-09	2.00	237943-12
FL 2x35	white	2.20	237941-00	2.80	237941-09	2.20	237941-12
FL 2x49	white	2.20	237942-00	2.80	237942-09	2.20	237942-12
FL 2x80	white	2.20	237944-00	2.80	237944-09	2.20	237944-12

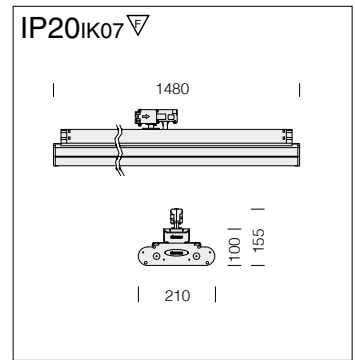
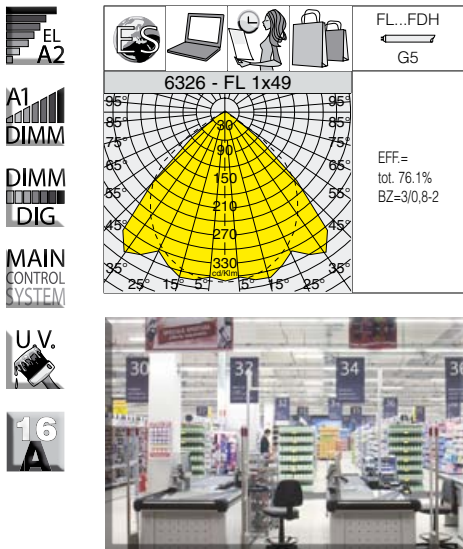

Housing: extruded aluminium with die-cast end caps.

Darklight Fixtures: longitudinal and transversal double parabolic dark-light fixtures built from high reflection, anti-glare, anti-iridescence, very low luminance aluminium, with PVD multilayer treatment (Physical vacuum Deposition).

Standard features: optics with snap fastening, which remain hooked on, hanging by nylon cords.

6326 Elesystem T5							
		CELL-F		CELL-F-D		Lamps	
wattage	colour	weight	code	weight	code	Kelvin - ølm - Ra	
FL 1x49	white	8.00	237442-00	8.00	237442-12	4000K - 4350lm	
FL 2x49	white	8.20	237443-00	8.20	237443-12		

Ideal for installation in shopping areas, to light checkout points.



Wide beam reflector polished matt aluminium 99,99 with PVD multilayer treatment. For one or two lamp T5.

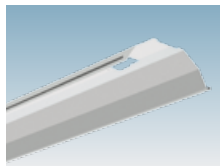
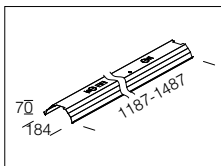
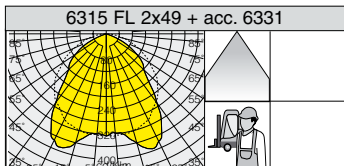

acc. 6331 wide beam T5	
1/2x54	237480-00
1/2x49	237481-00

Narrow-beam reflector polished high-gloss aluminium 99,99 with PVD multilayer treatment. For one or two lamp T5. Do not use with art. 6319/20/23.

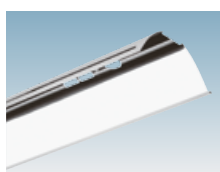
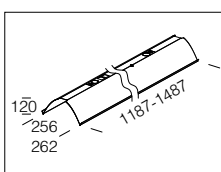
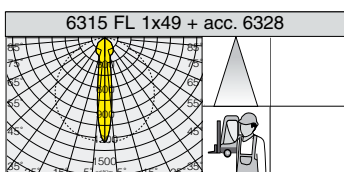

acc. 6328 narrow-beam T5	
1x54/28	237450-00
1x49	237451-00
2x54	237455-00
2x49/80/35	237456-00

Asymmetrical reflector, matt aluminium 99,99 with PVD multilayer treatment. For one or two lamp T5. Do not use with art. 6319/20/23.

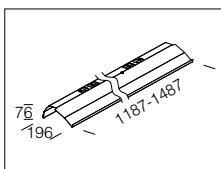
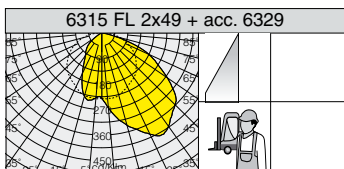

acc. 6329 asymmetrical T5	
1/2x54/28	237460-00
1/2x49/80	237461-00

Double asymmetrical reflector, matt aluminium 99,99 with PVD multilayer treatment. For one or two lamp T5. Do not use with art. 6319/20/23.

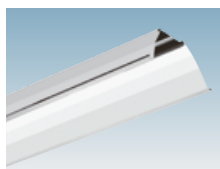
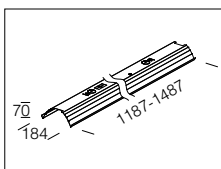
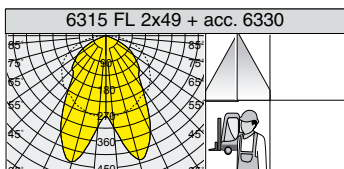

acc. 6330 asymmetrical T5	
1/2x54/28	237470-00
1/2x49/80	237471-00

Made of steel, pre-painted white with polyester resin, stabilized to UV; for one or two lamp.

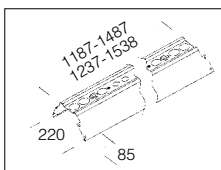
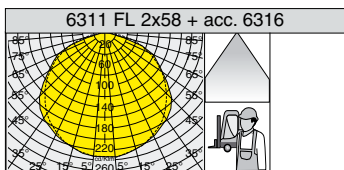

acc. 6316 wide beam reflector	
28/54	237410-00
35/49/80	237412-00
On request: reflector externally painted in grey RAL 7001.	

Polished high-gloss aluminium. For one or two lamp.

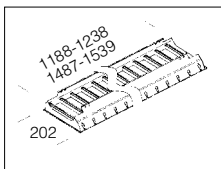
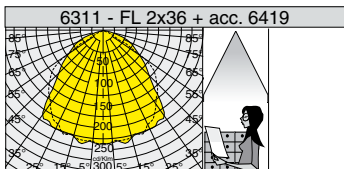

acc. 6319 louvre	
28/54	237422-00
35/49/80	237424-00
To be used with acc. 6316.	

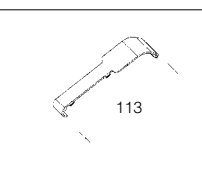

acc. 6320 cover	
white	237430-00
Made of thermoplastic material. To use in order to join together the optical diffusing in the case of assembly in continuous row. 2 per pack	



acc. 6323 end cap	
white	237436-00
Made of thermoplastic material. To close optical diffusing. 2 per pack	



acc. 6324 wall mounting unit	
white	237437-00
Die-cast aluminium spotlight holder box, painted white. To install Fosnova series floodlights.	



acc. 6410 protective tube	
1x28/54	237614-00
1x35/49/80	237615-00
Do not use with art. 6315.	