



**Housing:** extruded aluminium with die-cast end caps.

**Dark light optics:** double parabolic louvres, in high-gloss plated aluminium 99.99. Anti-glare and anti-iridescence, very low luminance. PVD treatment to increase light efficiency.

**Coating:** UV-stabilized polyester resin powder coating.

**Standard supply:** snap fastening optics, which remain attached by safety cords.

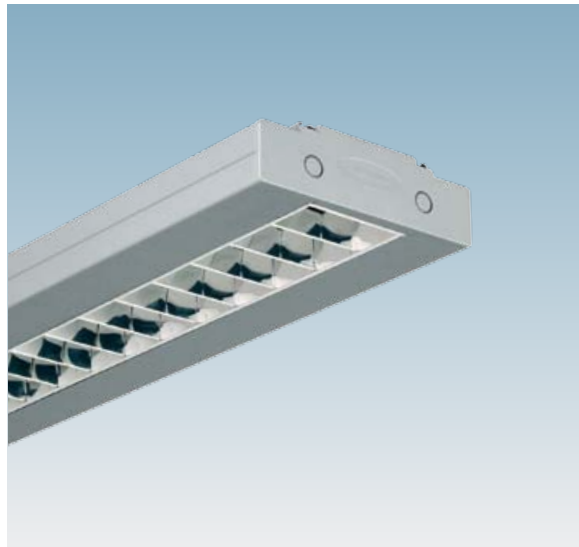
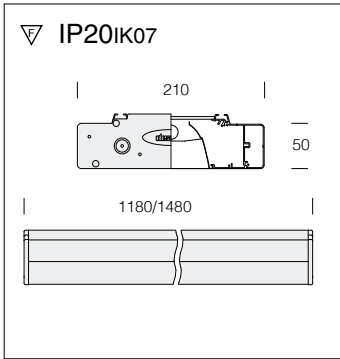

FL...FDH  
G5

3873 - FL 1x35

EFF =  
upp. 27,3%  
low. 63,5%  
tot. 90,80%  
BZ=4/4,0-3

Quick connection for easy and rapid installation and maintenance.



**Emergency version:** in maintained version. Run time 60 minutes (see chapter). On request: versions with 3 hour emergency duration.

**On request:** versions DIMDIG (digital dimming). Also available in the EM version.

**3873 Channel 1 - T5 - single one-lamp - high-gloss optical 99,99**

		CELL		CELL-E		CELL-D		Lamps (Ta=25°C)
wattage	colour	weight	code	weight	code	weight	code	Kelvin - ølm - Ra
FL 1x28	s. silver	4.10	145061-00	4.70	145061-07	4.10	145061-12	4000K - 2650lm - Ra 1b
FL 1x28	white	4.10	145065-00	4.70	145065-07	4.10	145065-12	
FL 1x35	s. silver	5.00	145062-00	5.70	145062-07	5.00	145062-12	4000K - 3350lm - Ra 1b
FL 1x35	white	5.00	145066-00	5.70	145066-07	5.00	145066-12	
FL 1x49	s. silver	5.00	145063-00	5.70	145063-07	5.00	145063-12	4000K - 4350lm - Ra 1b
FL 1x49	white	5.00	145067-00	5.70	145067-07	5.00	145067-12	

**3874 Channel 2 - T5 - single two-lamp - high-gloss optical 99,99**

		CELL		CELL-E		CELL-D		Lamps (Ta=25°C)
wattage	colour	weight	code	weight	code	weight	code	Kelvin - ølm - Ra
FL 2x28	s. silver	3.60	145071-00	4.20	145071-07	4.10	145071-12	4000K - 2450lm - Ra 1b
FL 2x28	white	3.60	145075-00	4.20	145075-07	4.10	145075-12	
FL 2x35	s. silver	4.30	145072-00	5.10	145072-07	4.80	145072-12	4000K - 3100lm - Ra 1b
FL 2x35	white	4.30	145076-00	5.10	145076-07	4.80	145076-12	
FL 2x49	s. silver	4.40	145073-00	5.10	145073-07	4.90	145073-12	4000K - 4100lm - Ra 1b
FL 2x49	white	4.40	145077-00	5.10	145077-07	4.90	145077-12	

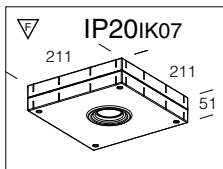

**acc. 3875 cube with CTL spotlight**

DICR 35 IRC	s. silver	145104-00
DICR 35 IRC	white	145105-00
POWER LED	s. silver.	145106-00
POWER LED	white	145107-00

In die-cast aluminium. To be used with "L", "T" or "X" joints.

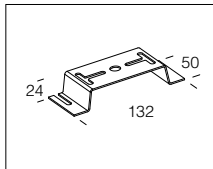

**acc. 376 ceiling mounting unit**

galvanized	145151-00
------------	-----------

For direct ceiling installation. Only for equipment with direct light. **2 per pack.**

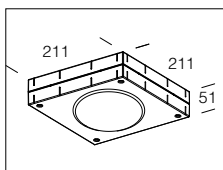

**acc. 397 simple cube**

s. silver	145098-00
white	145099-00

In die-cast aluminium. To be used with "L", "T" or "X" joints.

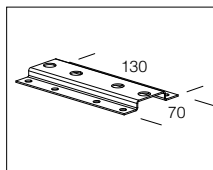

**acc. 2292 reinforcement plate joint**

m. silver	143999-00
-----------	-----------

To be used as a steel reinforcement in a continuous line. Be used for the row with 3 suspensions every 2 ceiling lights.

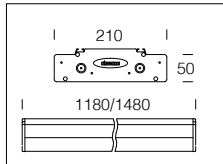

**acc. 395 "S1" module**

28 s. silver	145081-00
28 white	145090-00
35/49 s. silver	145082-00
35/49 white	145091-00

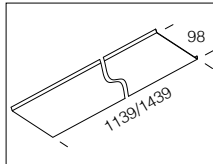

**acc. 375 upper cover**

28 white	145149-00
35/49 white	145150-00

For direct light only applications.

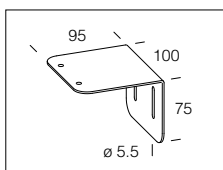

**acc. 2291 wall mounting unit**

galvanized	143998-00
------------	-----------

Galvanized sheet steel brackets. To install the lighting fixture directly onto wall surfaces. **2 per pack.**

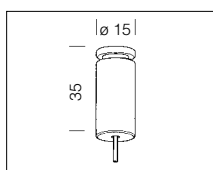

**acc. 2518 simple suspension**

galvanized	994019-00
------------	-----------

Suspension supplied with steel wire, 1.75 m long with millimetric adjustment. Max load: 20 kg.

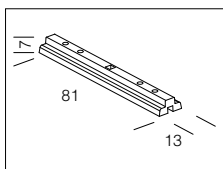

**acc. 2290 linear joint**

zama	143997-00
------	-----------

**2 per pack.**

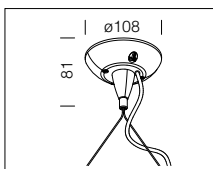

**acc. 2514 powered suspension**

m. silver	993919-00
-----------	-----------

Max load 20 kg. **3 poles.**

**acc. 2519 powered suspension**

m. silver	993909-00
-----------	-----------

Max load 20 kg. **5 poles.**